



QUALITY... PLAIN & SIMPLE®

**Lokar Cable Operated Sensor Kit Installation Instructions
For Chrysler 727, 904, and 518 Transmissions**

Lokar Cable Operated Sensor Kit Installation Instructions

For Chrysler 727, 904, and 518 Transmissions

Building American Quality... With A Lifetime Warranty!®

TOLL FREE 1-877-469-7440 • tech@lokar.com • www.lokar.com

General Installation Notes:

Please read these instructions completely before beginning the installation. If you have any questions, please call.

Before beginning the installation, disconnect the negative battery cable and use wheel chocks to block the vehicle's wheels. Do not attempt to install this product while the engine is running.

Make sure the engine, transmission, and frame are properly grounded. We recommend applying anti-seize lubricant to all aluminum threads before final assembly.

Refer to Fig. 1, 2 and 3 for the component names.

MOUNTING OPTIONS: The Lokar Cable Operated Sensor Kit is equipped to mount the sensor either on the passenger side of the transmission using the attached bracket, or in a remote location within 5 feet of the factory trans arm using the provided universal sensor bracket.

To mount the sensor remotely inside the vehicle, a Lokar Remote Mounting Cable Kit (part # CINR-1796) will be required. This extends the cable 7 feet, for a total of 12 feet.

The decoder box should always be mounted inside the vehicle and out of the elements.

Step 1: Assemble the upper and lower parts of the adjustable cable mounting bracket, installing two #8-32 x 5/16" button head screws and lock washers using a 5/32" Allen wrench, but do not tighten the screws fully yet. **Fig. 4**

Step 2: Just above the driver side rear corner of the transmission fluid pan is a large casting boss with a hole in it. Install the adjustable cable mounting bracket in that spot, using the 5/16"-18 x 1-1/4" bolt, lock washer, flat washer, and spacer. **Fig. 5**

Step 3: Remove the sensor cap by removing the two #10-24 x 1/2" flat head screws using a 1/8" Allen wrench, and separate the cable housing from the sensor. **Fig. 6**

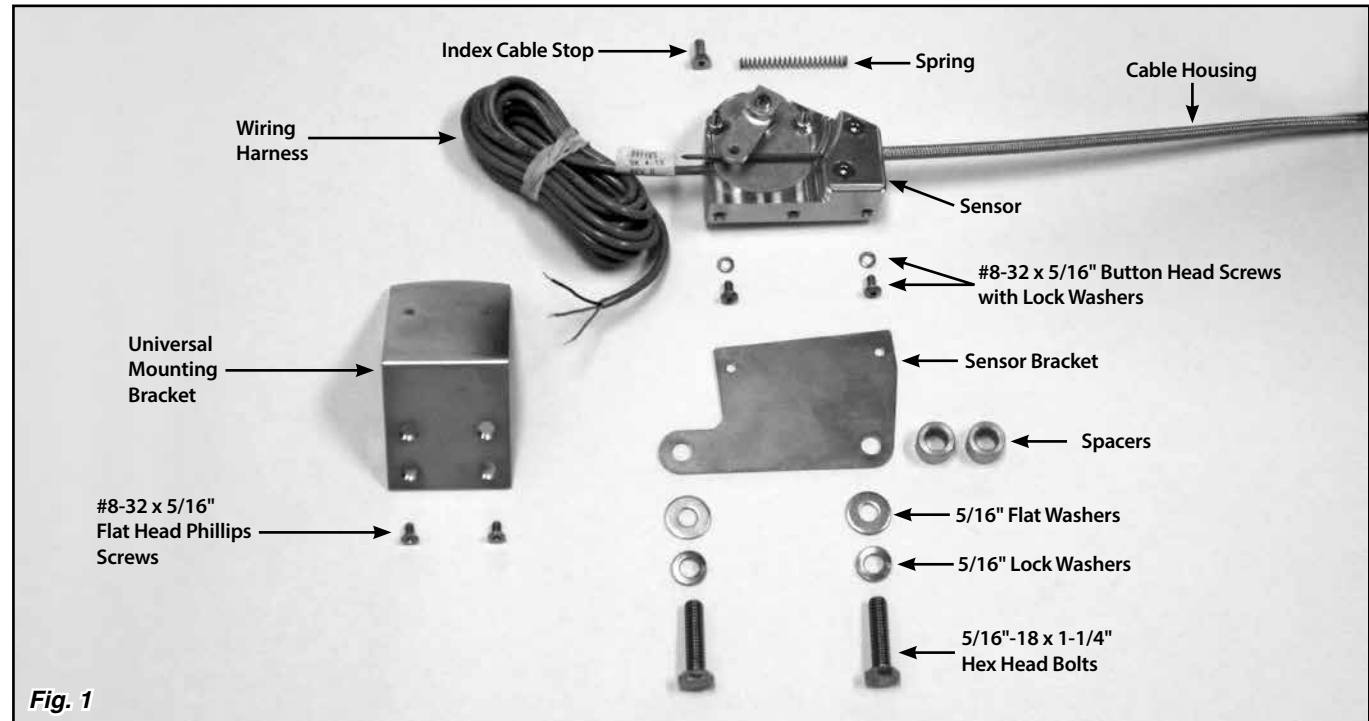

Fig. 1

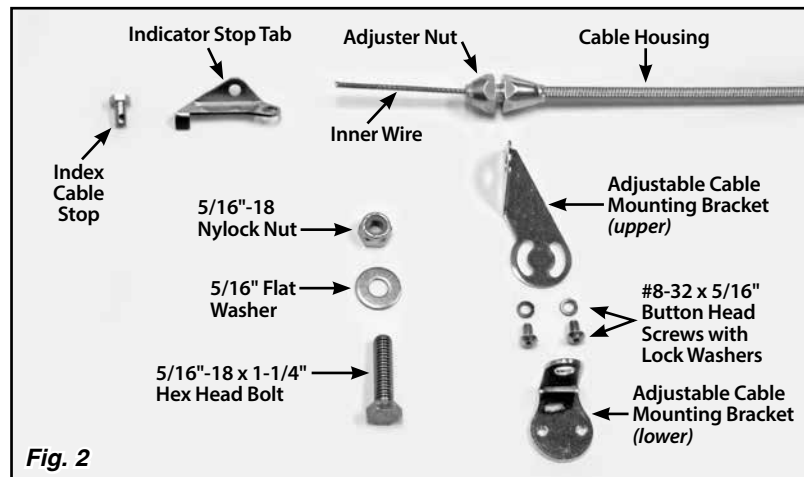

Fig. 2

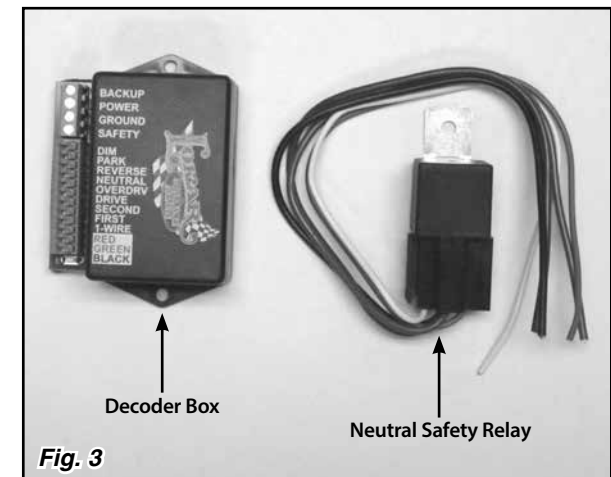

Fig. 3

Step 4: Make sure the sensor arm is parallel to the slot in the sensor shaft, with the set screw in the top of the sensor arm aligned with the slot. If not, loosen the set screw in the top of the sensor arm using a 1/16" Allen wrench, and adjust the position of the sensor arm on the shaft. **Fig. 7**

Step 5: This step varies, depending on where you are mounting the sensor. If you are mounting the sensor:

• **Directly onto the passenger side of the transmission:** Remove the second and third pan bolts to the rear of the dipstick tube. Use the provided 5/16" x 1-1/4" bolts, lock washers, flat washers, and spacers to mount the sensor bracket in that location. If you have a Lokar Transmount Shifter on the transmission, use the longer bolts and nylock nuts that came with the Shifter instead. If you have an aluminum transmission pan, the spacers may not be necessary. Tighten the transmission pan bolts that are used to mount the sensor bracket. **Fig. 8**

• **In a remote location:** Make sure the sensor is close enough that the cable housing can be routed into the back side of the adjustable cable mounting bracket. Install the universal mounting bracket onto the vehicle using the two smaller holes in the bracket and your choice of fasteners (not included). The small holes in the universal mounting bracket may be drilled out larger if needed. Once the universal mounting bracket is installed in the remote location, remove the sensor from the other sensor bracket. Install the sensor onto the universal mounting bracket, using the #8-32 x 5/16" flat head Phillips screws. There are two pairs of countersunk holes on the universal mounting bracket and three holes in the sensor to allow for different mounting positions.

Step 6: Remove the nut from the pinch bolt on your original trans arm. You may need to remove the pinch bolt also, depending on which direction it was previously installed. Install the indicator stop tab onto the pinch bolt, on the forward side of the trans arm, with the bent tab on top of the trans arm as shown in **Fig. 9**. Reinstall the original nut on the pinch bolt.

Step 7: Remove the inner wire from the cable housing. Temporarily install the threaded end of the cable housing into the adjustable cable mounting bracket and secure it with the adjuster nut.

The cable is designed to be cut-to-fit. Route the cable housing from the adjustable cable mounting bracket to the sensor.

There is a groove in the sensor housing that the end of the cable housing fits in to. Mark the cable housing at the end of the cable housing groove. Remove the cable housing from the adjustable cable mounting bracket. **Fig. 6 and Fig. 7**

Step 8: Make sure that the inner wire has been removed from the cable housing. Wrap tape around the area to be cut and use a cutoff wheel or fine-toothed hacksaw to cut the cable housing at your mark. You also may use heavy duty 8" diagonal cutting pliers. Lokar recommends Klein brand Diagonal Cutting Pliers, # D2000-28 available at The Home Depot or through W. W. Graingers, Part # 4A838.

Before moving forward make sure the end of the cable housing that you just cut is open and the inner wire will slide in without interference.

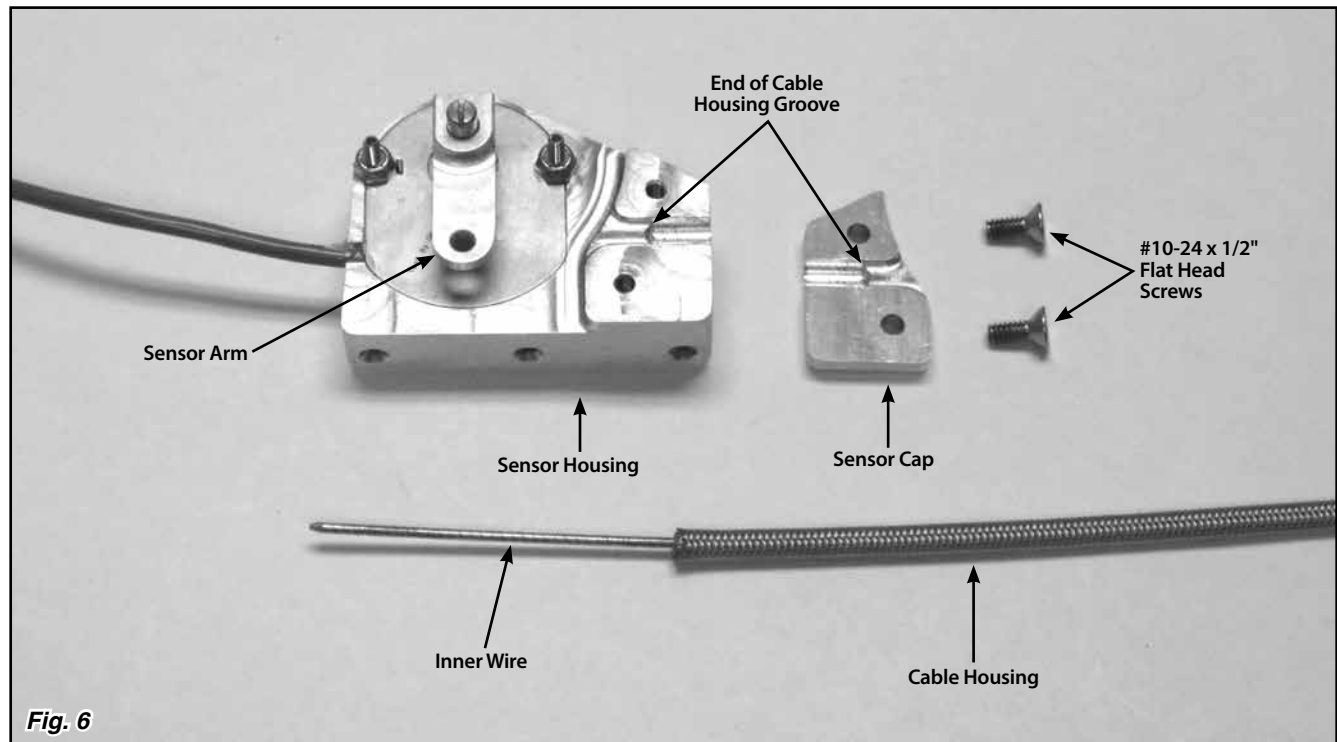
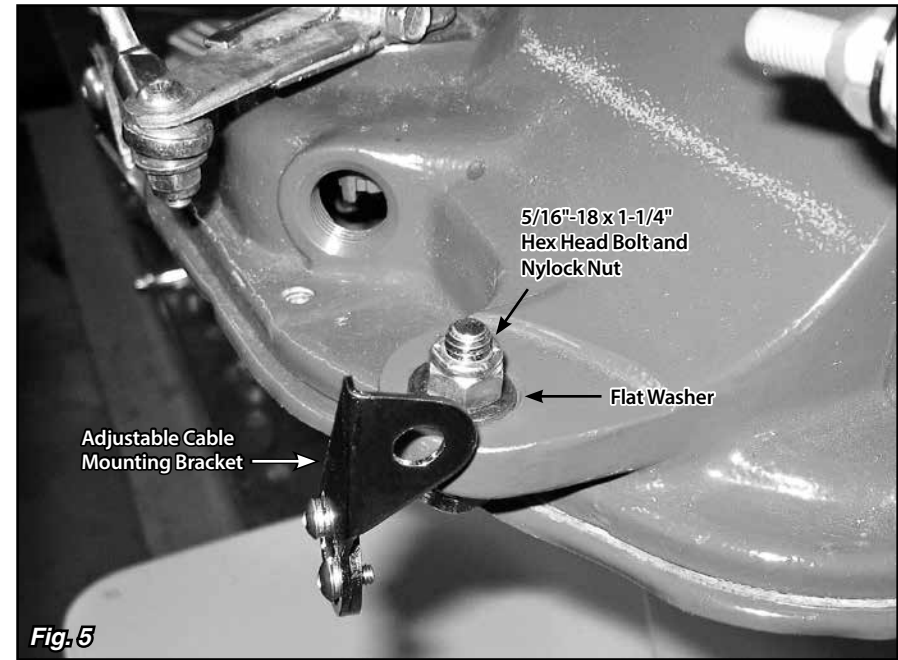

Step 9: Remove the sensor from the sensor bracket using a 5/32" Allen wrench. Reattach the cable housing to the sensor by clamping it between the sensor housing and the sensor cap, making sure the cable housing does not extend beyond the end of the cable housing groove in the sensor housing. Secure the sensor cap using the #10-24 x 1/2" flat head screws you removed earlier. Then, install the threaded end of the cable housing back into the adjustable cable mounting bracket.

Step 10: Slide the inner wire into the cable housing until it is protruding out both ends. Put the spring on the inner wire between the sensor arm and the sensor cap.

Install the index cable stop into the sensor arm with the cable hole between the sensor arm and the sensor. Slide the inner wire through the index cable stop, so that at least 1" is protruding beyond the index cable stop. Make sure the inner wire is on the correct side of the sensor arm. **Fig. 10**

Step 11: Reinstall the sensor onto the sensor bracket using the #8-32 x 5/16" button head screws and lock washers (transmission mounted sensor bracket) or the #8-32 x 5/16" flat head Phillips screws (universal mounting bracket).

Step 12: At the opposite end of the cable, install the index cable stop into the indicator stop tab, with the set screw at the top and the hole for the inner wire below the indicator stop tab. Guide the inner wire underneath the trans arm and slide the inner wire through the hole in the index cable stop so that approximately 1" is protruding. You should now have excess inner wire at the opposite end of the cable (at the sensor). Tighten the set screw in the index cable stop on the indicator trans arm using a 1/16" Allen wrench. Adjust the angle of the adjustable cable mounting bracket so that the inner wire will not bind or kink as it goes through the gear selections. **Fig. 11**

Note: It is very important that the cable housing is secured. Fasten the cable housing tightly so there is no slack or movement in the cable housing.

Step 13: Make sure the transmission is in Park. **Push the sensor arm up against the spring, so that the spring is compressed approximately 1/8" at rest in Park. Fig. 12** Tighten the set screw in the index cable stop on the sensor arm using a 1/16" Allen wrench. Trim the excess inner wire, leaving about 1" protruding.

Shift the transmission from Park, one gear at a time, and check each gear to make sure that the arm on the sensor does not hit the stop screws or anything else. The sensor arm does not need to be the same distance from the stop screws in Park as it is in low gear. If the sensor arm bottoms out before the shifter reaches first gear, loosen up one end of the inner wire at either of the index cable stops and move the indicator trans arm or sensor arm. **Make sure you maintain approximately 1/8" of compression on the spring at the sensor end of the cable when the transmission is in Park.**

Once the sensor is operating properly and no more adjustments need to be made, cut the excess inner wire within 1/2" of the index cable stop on both ends of the cable.

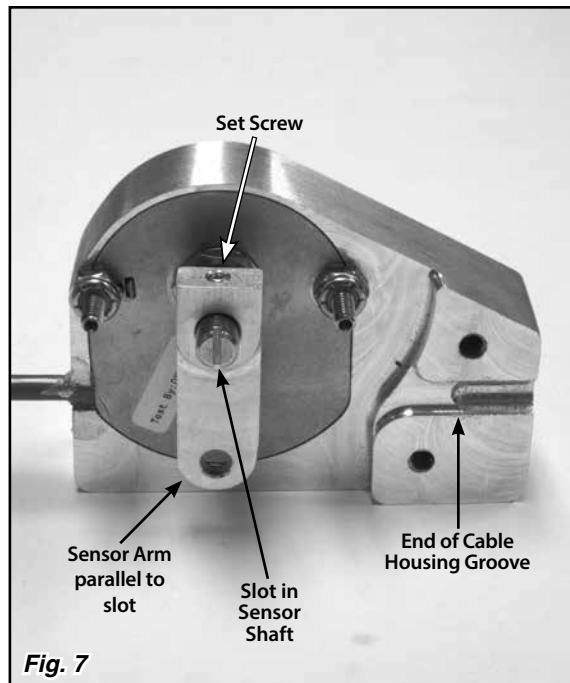

Fig. 7

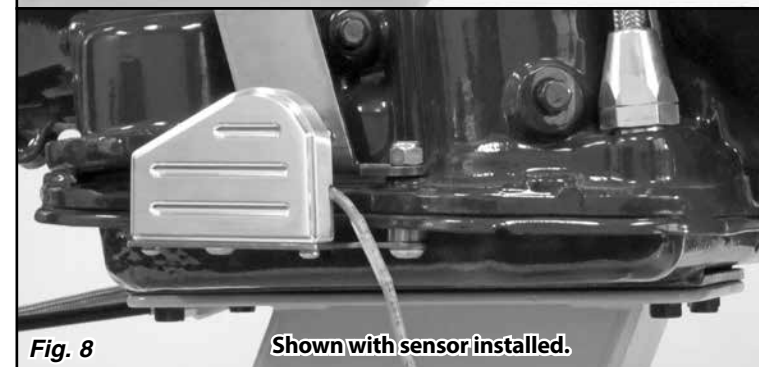
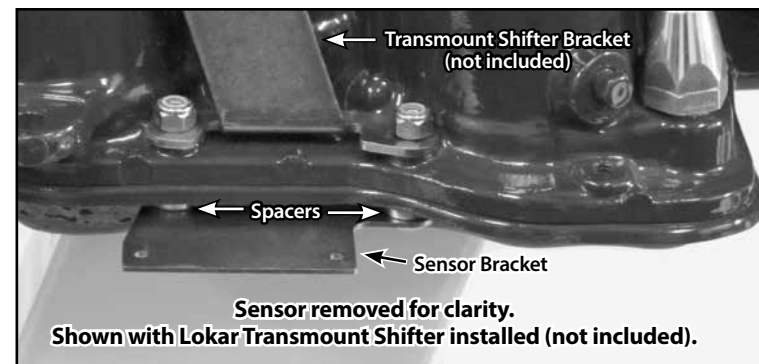

Fig. 8

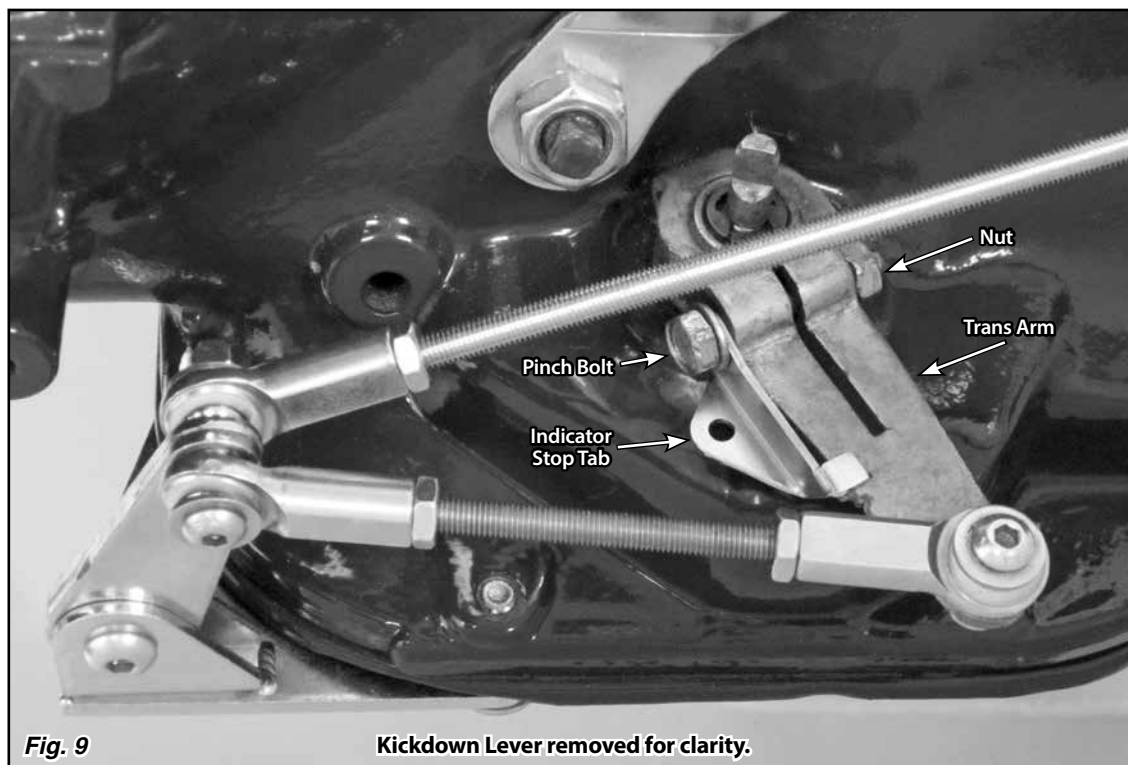

Fig. 9

Kickdown Lever removed for clarity.

Mounting The Decoder Box

The decoder box must be mounted in a dry place. When mounting this unit, keep it within the reach of the wires on the LED display and the sensor. The decoder box can be mounted with two screws or double-sided tape. Be sure it is still accessible for connecting the wiring and for programming later.

Wiring The Sensor and The Decoder Box

The sensor has a 10 foot long gray cable attached to it. This cable contains 3 wires which connect to the decoder box. To connect the wires to the decoder box, push down on the tab to insert the wire into the terminal on the decoder box. **Fig. 13** Connect the red wire to the terminal marked "RED". Connect the green wire to the terminal marked "GREEN". Connect the black wire to the terminal marked "BLACK".

NOTE: The red, green, and black wires coming from the sensor should ONLY be connected to the terminals marked "RED", "GREEN", or "BLACK" on the decoder box. DO NOT connect any of these three wires to the "POWER" or "GROUND" terminals on the decoder box.

Connect a fused (15 amp), 12V + power source to the "POWER" terminal on the decoder box. This should be a switched wire that supplies power when the ignition key is in the "ON" or "RUN" position, but does not supply power when the key is off. (**NOTE: If you are going to use the optional Neutral Safety Relay discussed below, this wire will also need to supply power while the key is in the "START" position.**)

Connect the red wire from the Lokar LED Boot Indicator (not included) or Dash Indicator (not included) to the same "POWER" terminal on the decoder box.

Connect a solid chassis ground to the "GROUND" terminal on the decoder box. **Fig. 14**

NOTE: When you are finished with this step, there will be two (2) red wires connected to the "POWER" terminal on the decoder box; one from a fused (15A) 12V + power source, the other from the Lokar LED Boot Indicator or Dash Indicator. There will only be one (1) wire connected to the "GROUND" terminal on the decoder box.

Programming The Gear Positions

Programming is done using the push-button set switch located below the sensor connection terminals and watching the programming LED's (not visible until power is applied) located between the sensor connection terminals and the body of the decoder box. The **PARK** light is directly behind the **PARK** terminal, **REVERSE** light is directly behind the **REVERSE** terminal, etc.

NOTE: For the programming procedures below, you will be watching the LEDs on the decoder box, NOT on the boot indicator or dash indicator.

The programming sequence must be completed without interruption for the settings to be saved. If you stop or turn the key off at any point during the programming sequence, you will have to start over again from the beginning.

Step 1: Place the transmission in Park and make sure the key is off. Reconnect the negative battery cable.

Step 2: Press and hold the set switch. **Fig. 13** Turn the ignition key on while holding the set switch down. Then, release the set switch.

Step 3: The lights will come on either all green or all red. All green means the decoder box is currently set for ground (-) outputs, which is correct for a Lokar Indicator. If you are using a Lokar Indicator and your lights are all green at this point, proceed to **Step 4**.

If the lights are all red, that means the decoder box is currently set for positive (+) outputs, which some other brands of indicators use. If your lights are all red, and you are using a Lokar Indicator, press and release the set switch. This will change the mode of the decoder box to ground (-) outputs. The lights will then turn green, and you can then proceed to **Step 4**.

If you are using an indicator from another manufacturer, determine if your indicator requires ground (-) outputs or positive (+) outputs. Press and release the set switch if needed to put the decoder box in the correct mode for the other manufacturer's indicator. Follow the instructions provided with the other manufacturer's indicator.

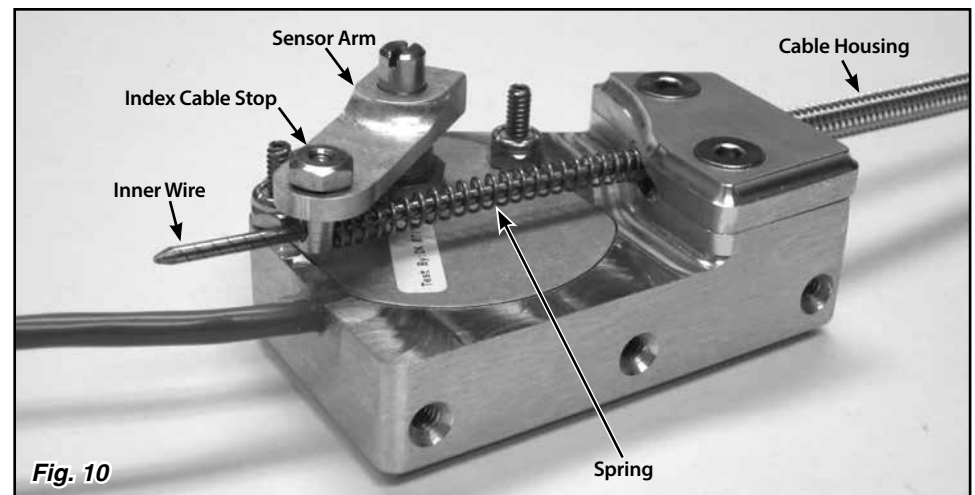

Fig. 10

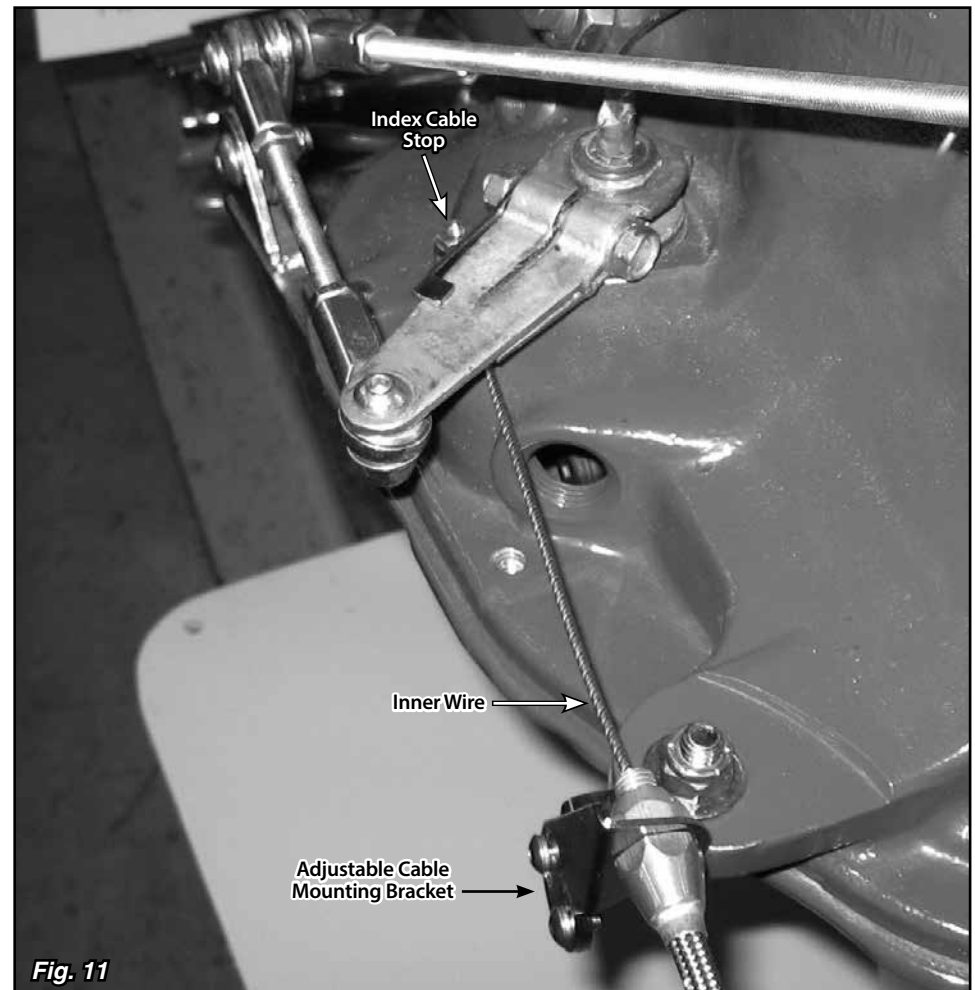

Fig. 11

Step 4: Press and hold the set switch for a few seconds until all the red and green lights turn on, to save the setting and put the decoder box in programming mode. Then, release the set switch. For a Lokar Indicator, the program lights on the decoder box should now be red with the **PARK** light alternating between green and red.

Step 5: Press and hold the set switch until the **PARK** light remains on steady.

Step 6: Release the set switch. The **PARK** light will go out, and the **REVERSE** light should begin flashing.

Step 7: Shift the transmission to Reverse.

Step 8: Press and hold the set switch. The **REVERSE** light should remain on steady. (If the **REVERSE** light will not quit flashing, then the sensor is not moving.)

Step 9: Release the set switch. The **REVERSE** light will go out, and the **NEUTRAL** light should begin flashing.

Step 10: Shift the transmission to Neutral.

Step 11: Press and hold the set switch. The **NEUTRAL** light should remain on steady. (If the light will not quit flashing, then the sensor is not moving.)

Step 12: Release the set switch. The **NEUTRAL** light will go out, and the **OVERDRIVE** light should begin flashing.

Step 13: Shift the transmission to Drive.

Step 14: Press and hold the set switch. The **OVERDRIVE** light should remain on steady. (If the light will not quit flashing, then the sensor is not moving.)

Step 15: Release the set switch. The **OVERDRIVE** light will go out, and the **DRIVE** light should begin flashing.

Step 16: Press and hold the set switch. The **DRIVE** light should remain on steady.

Step 17: Release the set switch. The **DRIVE** light will go out, and the **SECOND** light should begin flashing.

Step 18: Shift the transmission to Second gear.

Step 19: Press and hold the set switch. The **SECOND** light should remain on steady.

Step 20: Release the set switch. The **SECOND** light will go out, and the **FIRST** light should begin flashing.

Step 21: Shift the transmission to First gear.

Step 22: Press and hold the set switch. The **FIRST** light should remain on steady. (If the light will not quit flashing, then the sensor is not moving.)

Step 23: Release the set switch. The **FIRST** light will go out and then come back on steady.

Step 24: Shift the transmission through each of the gears to verify that the programming lights match correctly.

Step 25: Following the wiring diagram in **Fig. 14**, connect the rest of the wires from the LED indicator to the decoder box.

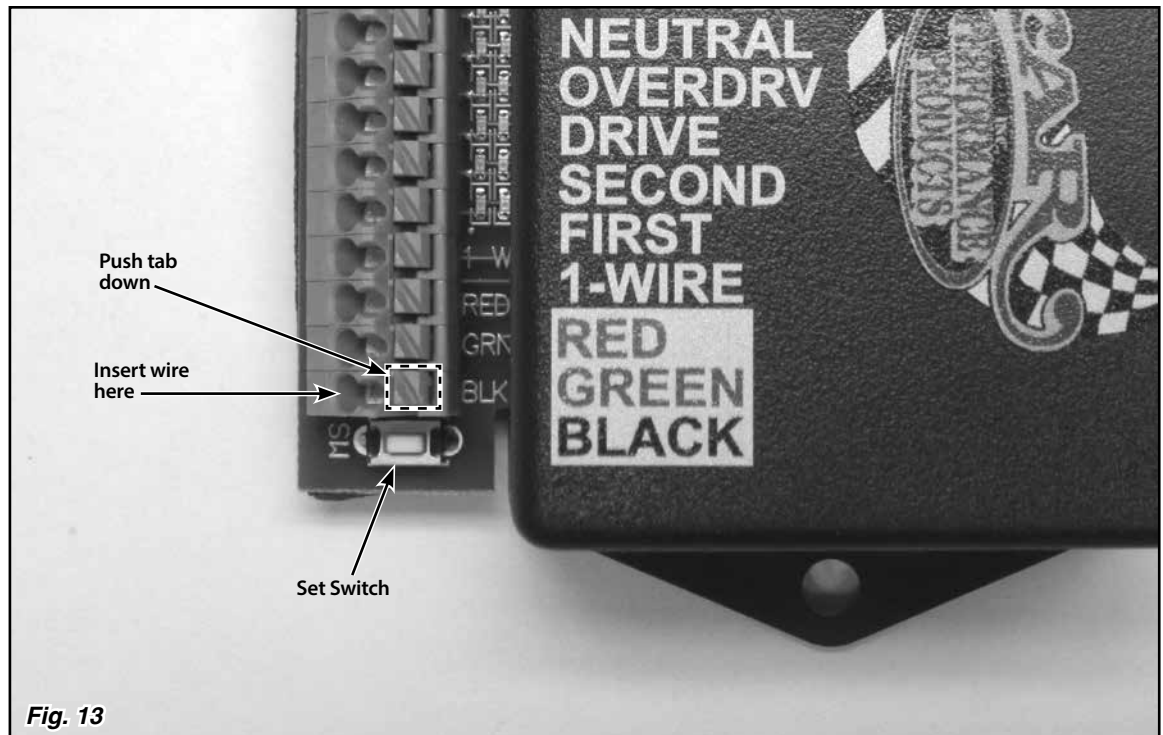
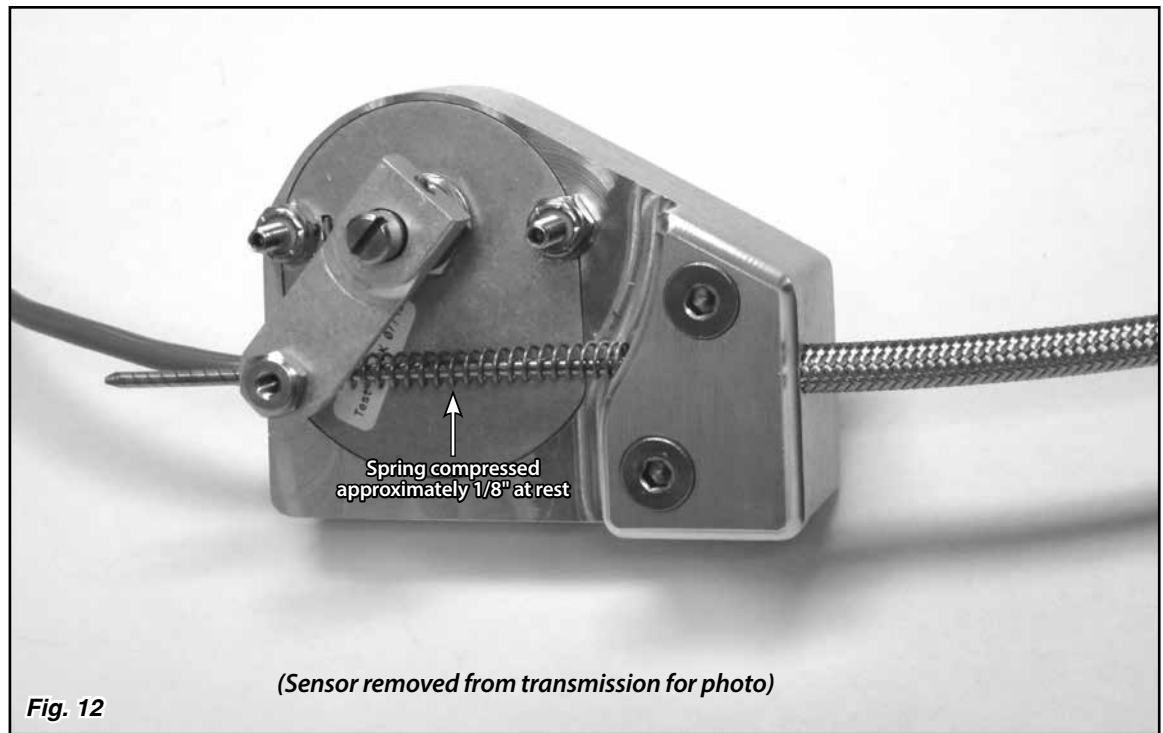

Optional Features and Wiring

NOTE: You must complete the "Programming the Gear Positions" section before connecting the wiring for any of the "OPTIONAL" sections below.

OPTIONAL: Connecting The Neutral Safety Relay

If your vehicle already has a neutral safety switch in the wiring harness to prevent the vehicle from starting while it is in gear, then you do not need to use the neutral safety switch feature in the decoder box, and you will not need to connect this relay.

If your vehicle does not already have a neutral safety switch, cut the wire that goes from your starter switch to the starter solenoid. Connect the wire coming from the ignition switch to the GREEN wire from the relay, and connect the BLACK wire from the relay to the wire going to the starter solenoid. For wiring harnesses which provide wires for the neutral safety relay, connect one side to the GREEN wire and the other side to the BLACK wire.

The WHITE wire from the relay connects to the "SAFETY" terminal on the decoder box. The RED wire connects to the power wire for the decoder box. For the neutral safety switch to operate properly, the "POWER" terminal on the decoder box must have power when the key is in the "START" position. **Fig. 15**

OPTIONAL: Connecting The Park/Neutral Signal To An ECM

If your vehicle is fuel injected and the ECM requires a signal when the transmission is in either Park or Neutral, the neutral safety terminal on the decoder box can be used. The "SAFETY" terminal provides a ground when the transmission is in Park or Neutral. This can be connected to the ECM in order to pass vehicle inspection. The "SAFETY" terminal can be used for both a neutral safety and an ECM signal at the same time.

OPTIONAL: Connecting Backup Lights To The Decoder Box

If your vehicle already has a backup light switch, then you do not need to connect anything to the "BACKUP" terminal. If you do not have a backup light switch and will be using backup lights on your vehicle, then connect the hot side of the backup lights to the terminal marked "BACKUP". This circuit is designed to supply up to 15 amps.

OPTIONAL: Enabling the Indicator's "DIM" Function

If you want the Indicator's LEDs to dim at night, locate a wire or terminal that only has power when your parking lights or headlights are on. Connect a wire from that wire or terminal to the "DIM" terminal on the decoder box.

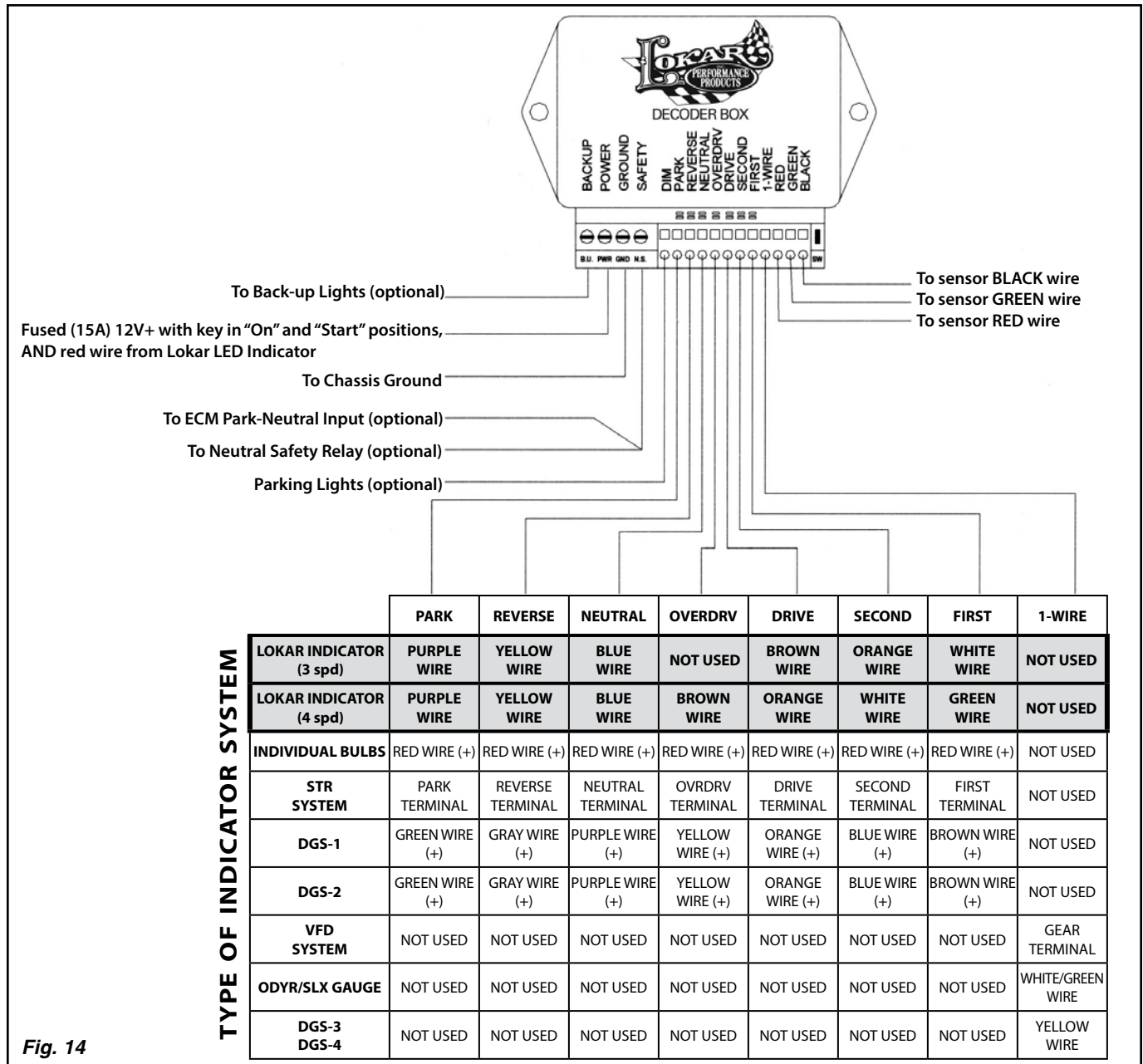

Fig. 14

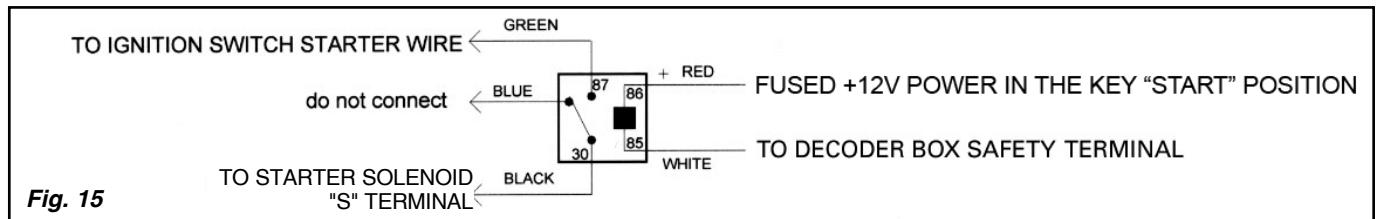

Fig. 15