



QUALITY... PLAIN & SIMPLE®

## Direct Fit Brake & Clutch Pedal Arm Installation Instructions For Kugel 90 Degree Pedals (Steel or Aluminum Pedal Arms)

### General Installation Notes:

Please read these instructions completely before beginning the installation. If you have any questions, please call.

Before beginning the installation, disconnect the negative battery cable and use wheel chocks to block the vehicle's wheels.

We recommend using anti-seize lubricant on all aluminum threads.

### Kugel 90 Degree Brake Pedal Arm Installation

*This section is for a brake pedal only installation (no clutch pedal).  
See Page 2 if you are installing both a brake and a clutch pedal.*

Refer to Fig. 1 for the component names.

**Step 1:** Disconnect the rod end on the master cylinder pushrod from the original brake pedal arm. Remove the axle bolt from the pedal hanger bracket, and slide out the brake pedal axle and brake pedal arm together.

**Step 2:** Lubricate the original brake pedal axle with a thin coat of light weight oil and insert it into the bronze bushing that is pressed into the new Lokar Brake Pedal Arm. It must fit smoothly with no tight spots. If the axle does not fit through smoothly it may require some sanding of the axle or a slight hone of the bushing.

**Step 3:** Install two 1/2" Delrin® spacers onto the axle, one on each side of the Brake Pedal Arm. **Fig. 2** Slide the brake pedal assembly with the axle and spacers up into the pedal hanger bracket and reinstall the original axle bolt and nylock nut (not included). Make sure the Brake Pedal Arm moves back and forth smoothly.

**Step 4:** Attach the rod end (not included) to the Brake Pedal Arm using the supplied 3/8"-24 x 1-3/4" bolt and nylock nut. Before tightening the nut, adjust the Brake Pedal Arm to the desired height. This can be done by turning the rod end in or out. Tighten the nut after the adjustment is finished.

**Step 5:** Adjust the brake light switch by loosening the two jam nuts on the switch. Turn the switch in or out as required. The brake light should turn on when the Brake Pedal Arm is depressed approximately 1/2". Make sure the brake lights are not on with the Brake Pedal Arm in the at-rest position.

The completed installation should look like **Fig. 3**.

# Direct Fit Brake & Clutch Pedal Arm Installation Instructions For Kugel 90 Degree Pedals (Steel or Aluminum Pedal Arms)

Building American Quality... With A Lifetime Warranty!®

TOLL FREE 1-877-469-7440 • tech@lokar.com • www.lokar.com

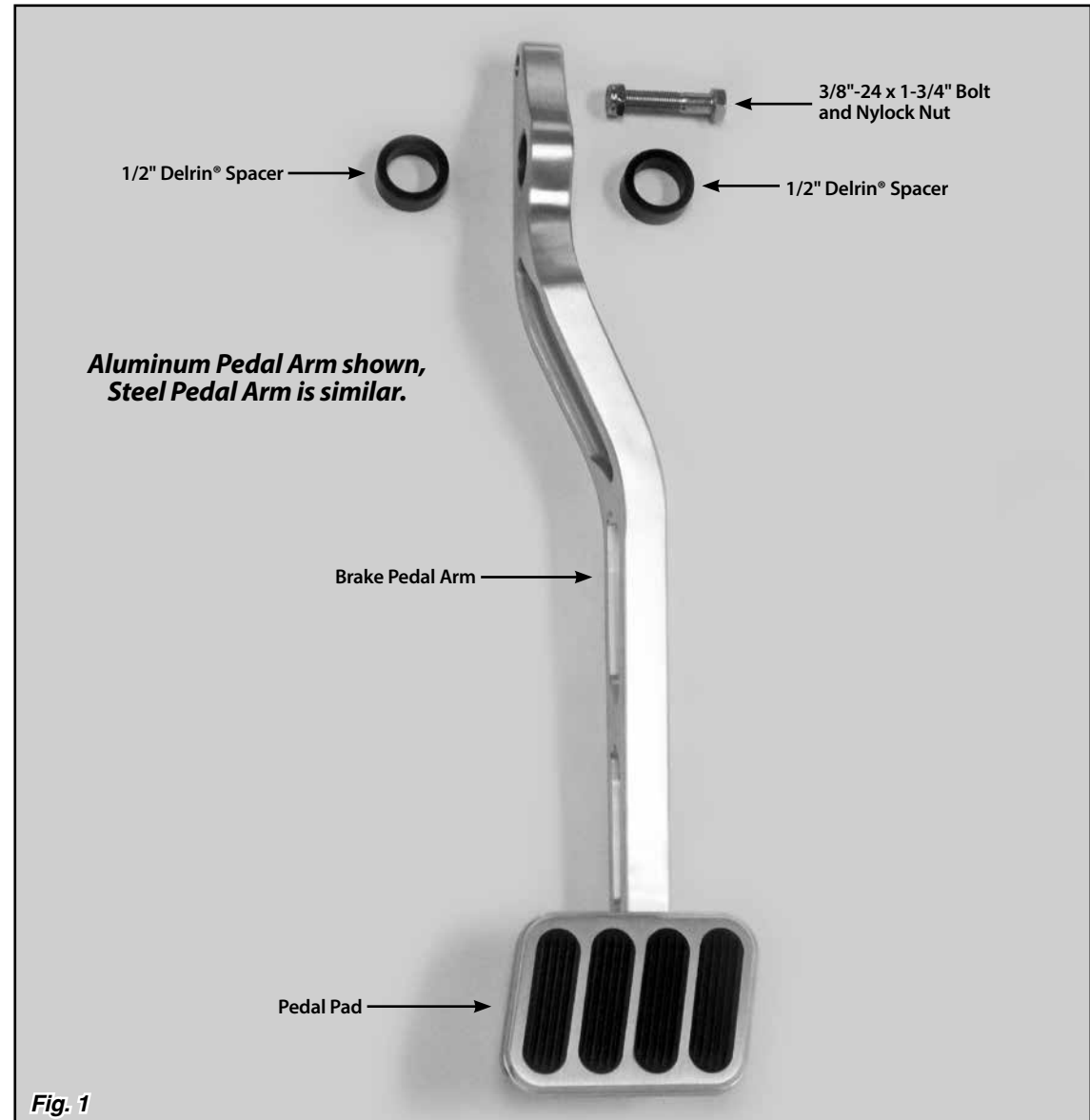

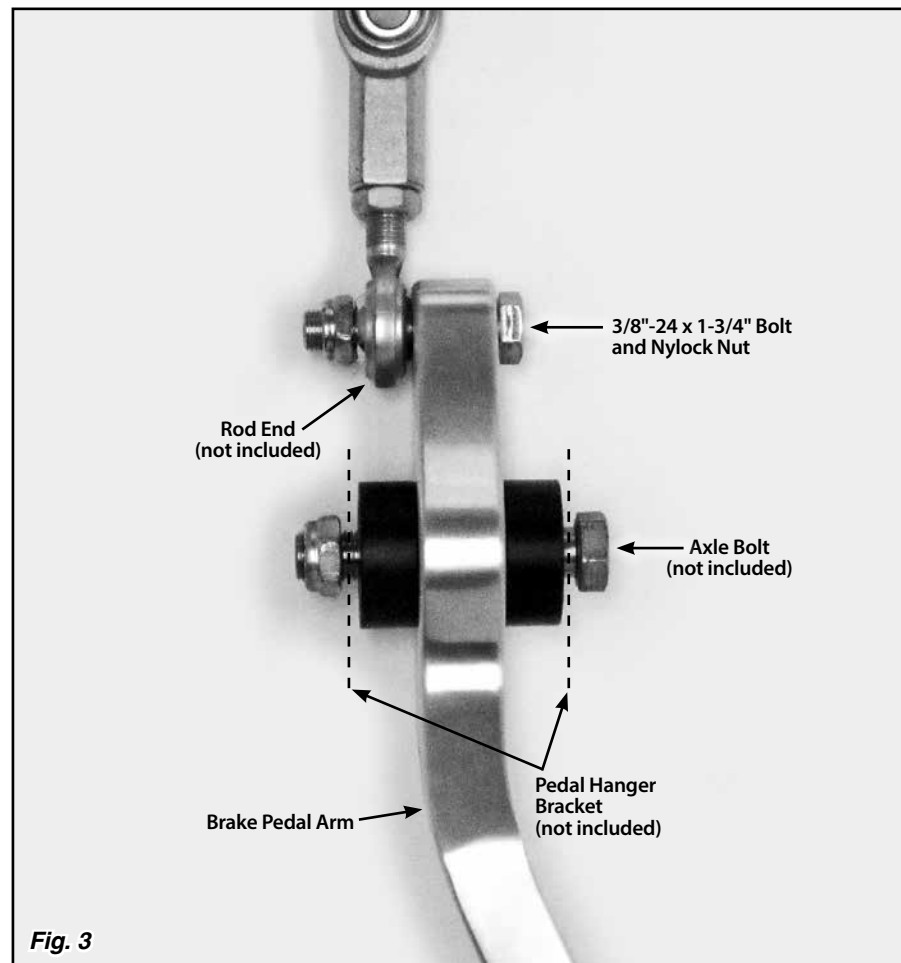
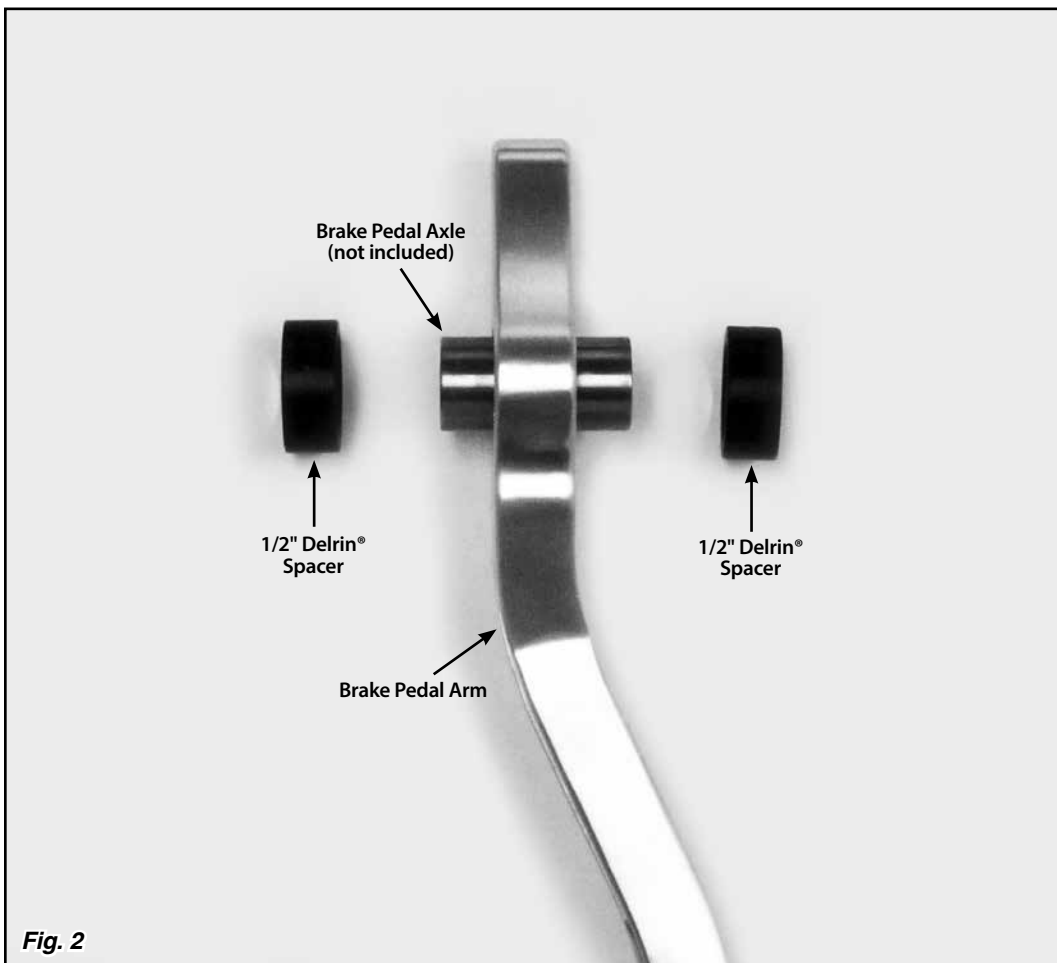

**Kugel 90 Degree Brake And Clutch Pedal Arm Installation**

Refer to Fig. 4 for the part names.

- Step 1:** Disconnect the rod ends on the pushrods from the existing brake and clutch pedal arms. Remove the axle bolts from the pedal hanger bracket. Slide out the brake and clutch pedal axle and pedal arms. Remove the existing brake light switch and mounting tab (if applicable).
- Step 2:** Lubricate the original brake and clutch pedal axle with a thin coat of light weight oil and test fit it into the bronze bushings that are pressed into the new Lokar Brake and Clutch Pedal Arms; the axle must fit smoothly with no tight spots. If the axle does not fit through smoothly, it may require some sanding of the axle or a slight hone of the bushing.
- Step 3:** Install the long (1-3/16") Delrin® spacer on the axle. Install the Brake Pedal Arm onto the axle to the passenger side of the spacer, and install the small (1/8") Delrin® spacer to the passenger side of the Brake Pedal Arm. Slide the Clutch Pedal Arm onto the driver side end of the axle, followed by the medium (15/16") Delrin® spacer to the driver side of the Clutch Pedal Arm. **Fig. 5**

- Step 4:** Slide the Brake and Clutch Pedal Arm assembly with the axle and spacers up into the pedal hanger bracket. Install and tighten the bolts and lock washers into both ends of the axle. Make sure the Brake and Clutch Pedal Arms move back and forth smoothly.
- Step 5:** Connect the rod ends (not included) to the Brake and Clutch Pedal Arms. The Brake Pedal Arm uses the supplied 3/8"-24 x 1-3/4" bolt and nylock nut. The Clutch Pedal Arm uses the supplied 5/16"-24 x 1-1/2" bolt and nylock nut. **Fig. 6** Before tightening the nuts, adjust the Brake and Clutch Pedal Arms to the desired height. This can be done by turning the rod ends in or out. Tighten the nuts after the adjustments are finished.
- Step 6:** Install the brake light switch tab that came with the Lokar Brake and Clutch Pedal Arms using the original Kugel hardware. Install the brake light switch (not included) into the brake light switch tab. **Fig. 7** Turn the brake light switch in or out as required to adjust the switch. The brake light should turn on when the Brake Pedal Arm is depressed approximately 1/2". Make sure the brake lights are not on with the Brake Pedal Arm in the at rest position.

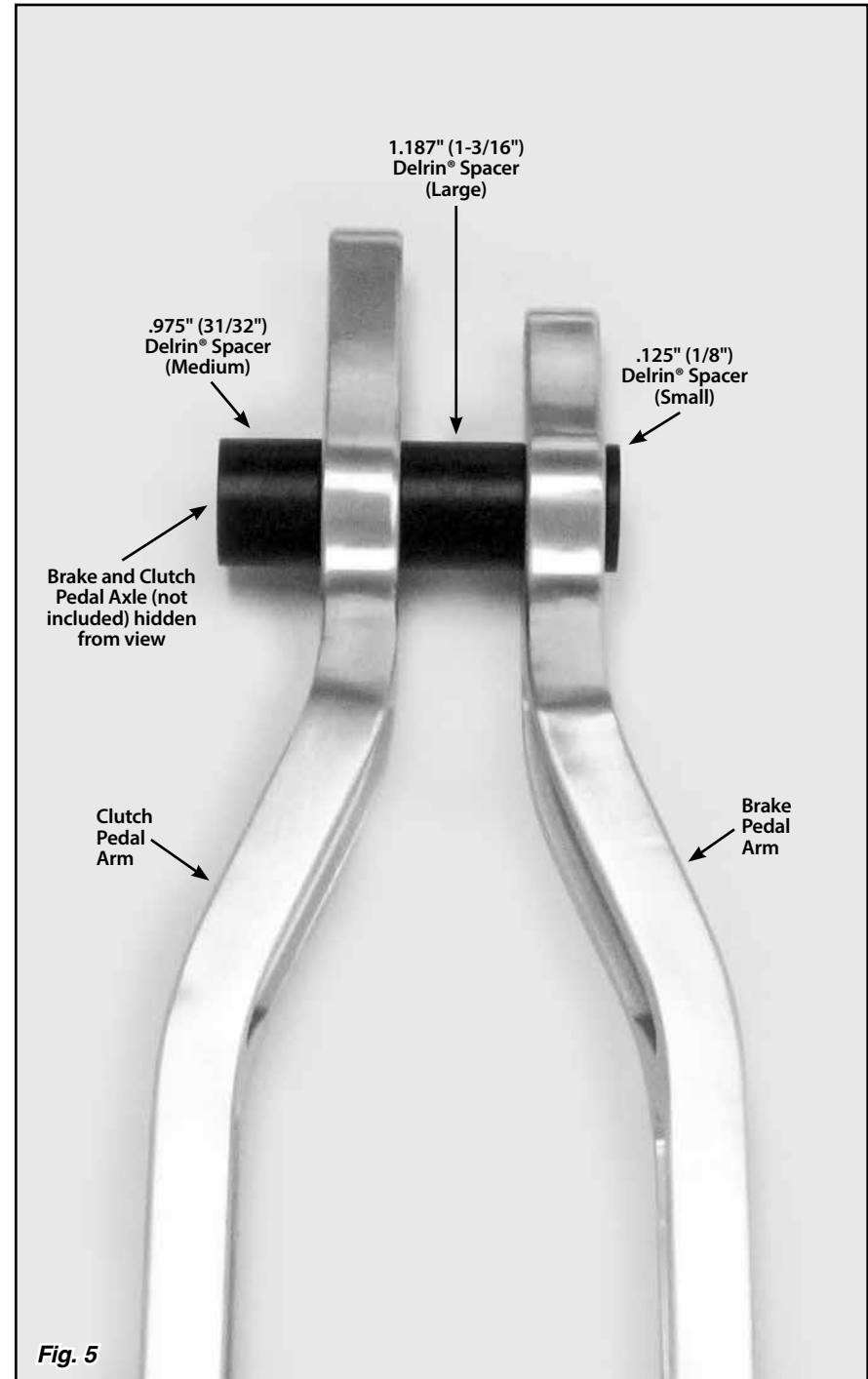
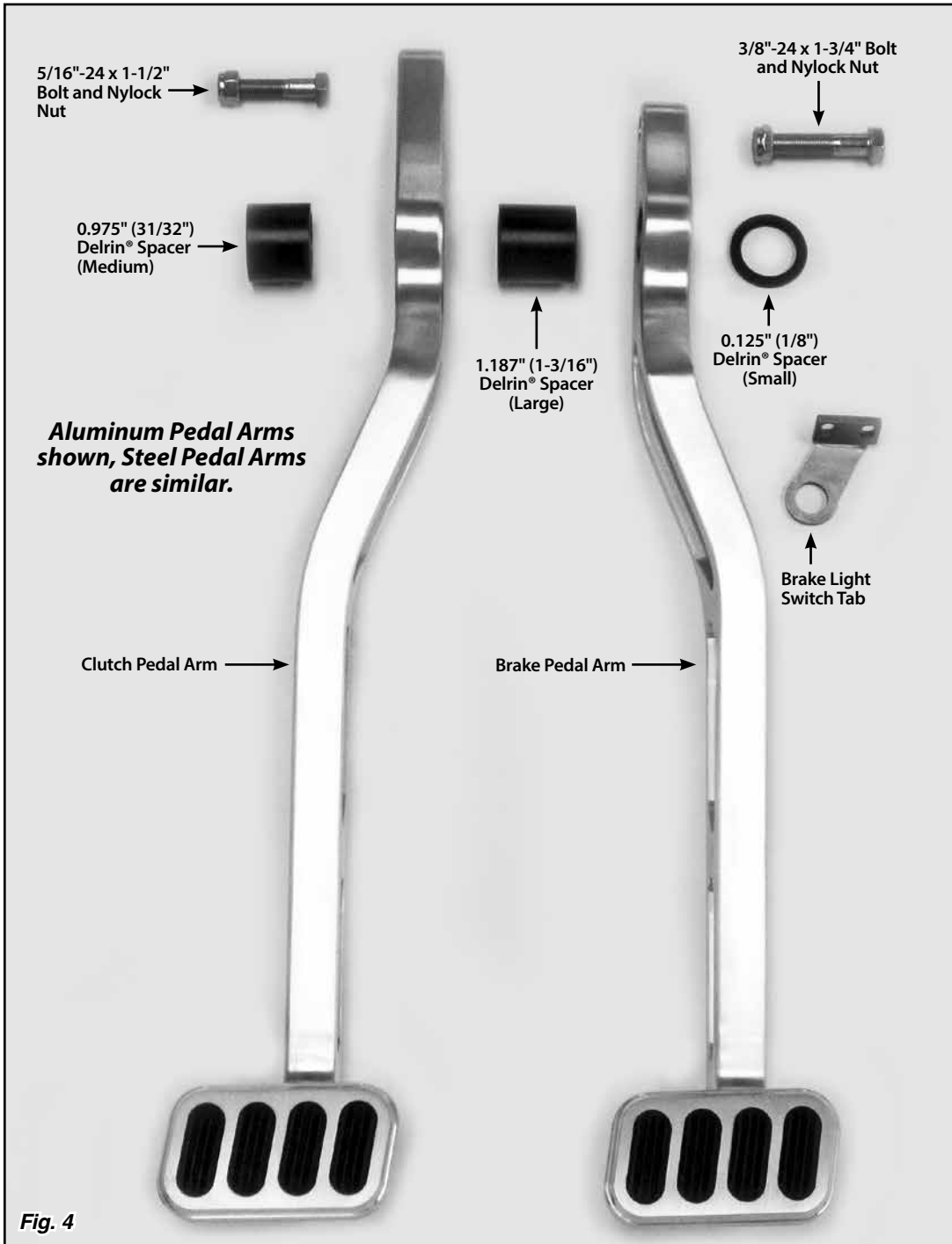

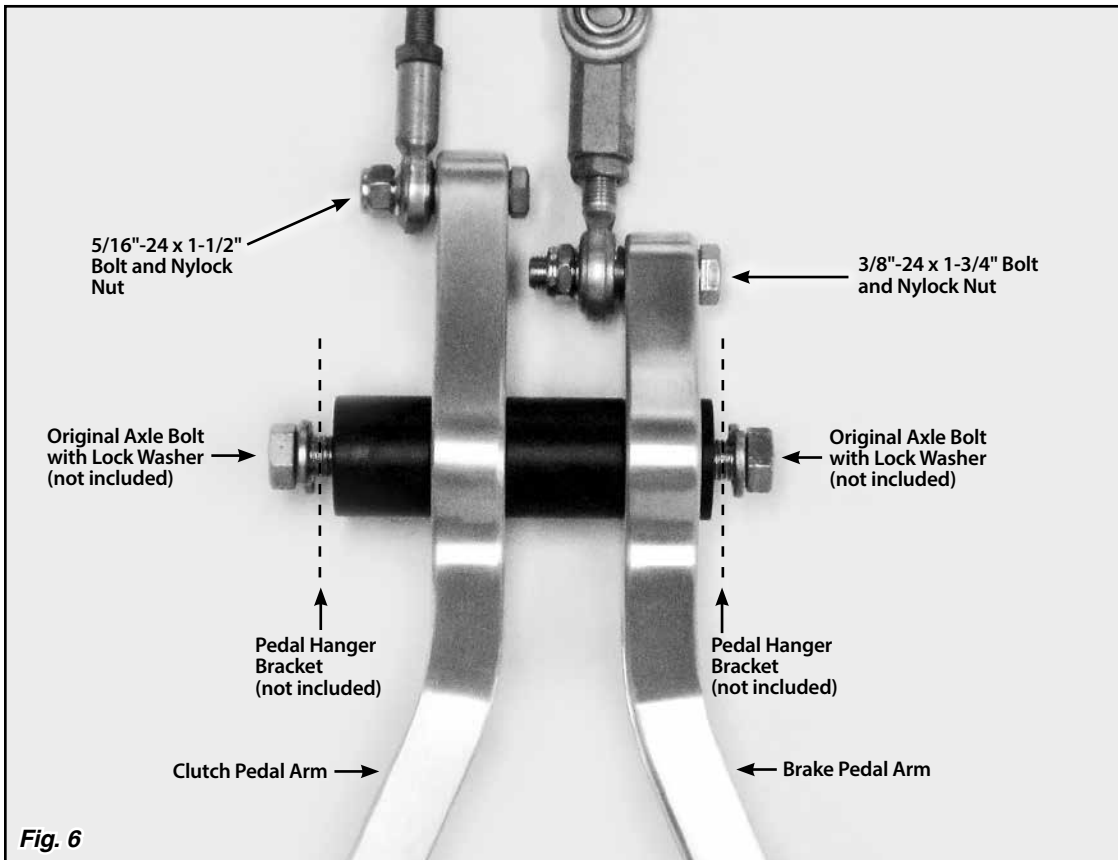

Fig. 6

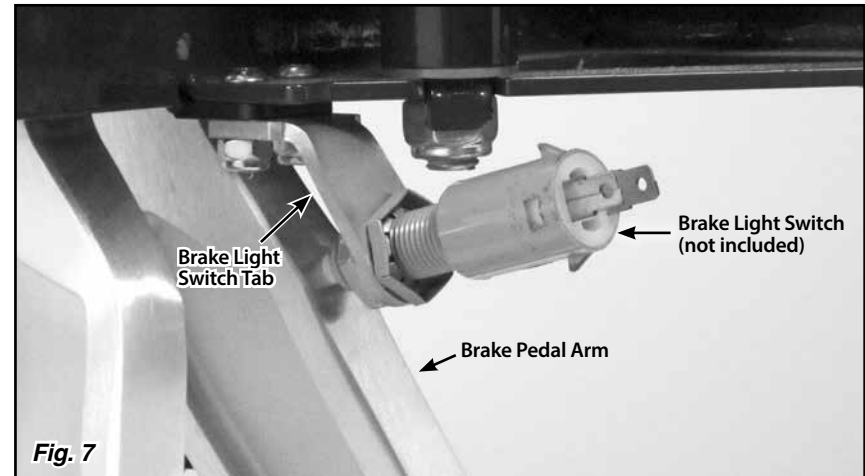

Fig. 7

**NOTE:** Some styles of Lokar pedals have a reversible pedal pad that can be turned around to shift the position of the pad to the left or right. Each of these pedal pads will come with one of the rubber inserts not installed, and there will be a tube of instant adhesive in the kit.

If you have one of the styles with a reversible pedal pad and you would like to reverse it, simply remove the two flat head bolts from the pedal pad, rotate the pedal pad one half turn, and reinstall the flat head bolts. **Fig. 8**

Attach the rubber inserts to the aluminum pedal pad using the adhesive supplied in the kit.

Read the adhesive manufacturer's instructions for proper application. If excess adhesive gets on the aluminum pedal pad, clean it off with acetone before it dries. Apply a small amount of adhesive to the bottom of the recess in the aluminum pedal pad only. Install the rubber insert into the aluminum pedal pad, and apply pressure to the rubber insert for 60 seconds.

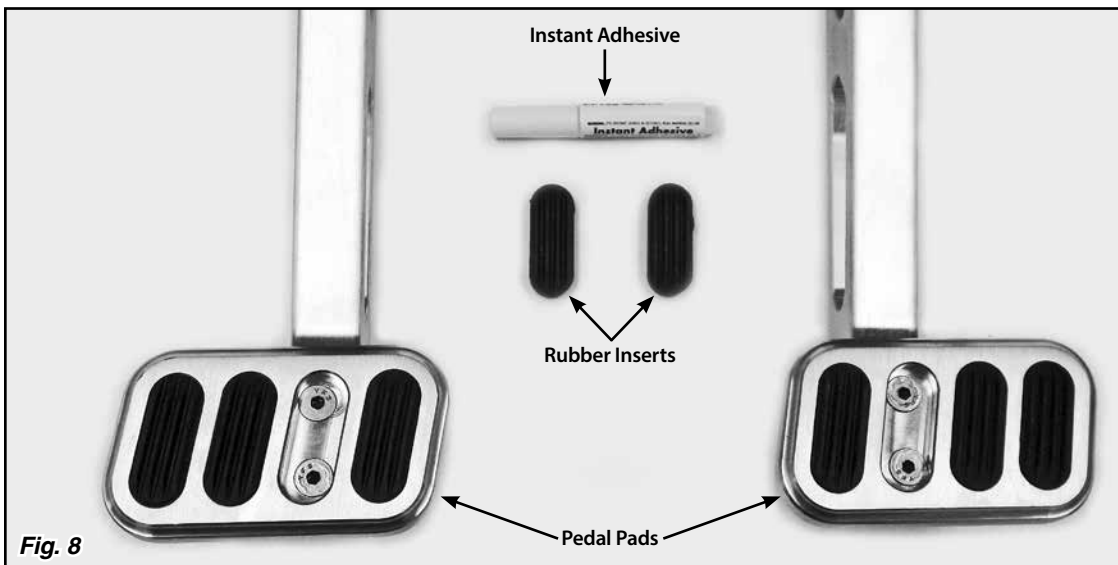

Fig. 8

### Instant Adhesive

**Hazards Identification:** Irritant. Irritating to eyes, skin, and respiratory system. Cyanoacrylate. Danger. Bonds skin and eyes in seconds.

**Ingredients:** Ethyl Cyanoacrylate

**Symptoms of Exposure:** Vapor irritating to eyes and respiratory system. Prolonged exposure may lead to non-allergic asthma.

**First Aid Measures:** **Ingestion:** Ingestion not likely due to polymerization.

**Inhalation:** Remove to fresh air. If symptoms continue, seek medical advice.

**Skin Contact:** Soak in warm soapy water.

**Eye Contact:** Flush with water, seek medical attention.

**KEEP OUT OF REACH OF CHILDREN**

**Additional Product Safety and Health Information Source:**

Material Safety Data Sheet (MSDS RP, SI, FS, HT, & MG Series Cyanoacrylate Adhesive) or 1-800-255-3924